

MARSDEN



Accuracy Assured

USER MANUAL

M-600

M-605

Please take time to read these instructions before starting to use the scale



Tel: 01709 364296 / 0800 169 2775

Fax: 01709 364293

E-mail: sales@marsdengroup.co.uk

Manufacturing and Distribution:

Unit 7, Centurion Business Park,

Coggin Mill Way,

Rotherham,

S60 1FB

Head Office:

Unit 1, Genesis Business Park,

Sheffield Road,

Rotherham

S60 1DX

www.marsden-weighing.co.uk

Version 1.1 10/17

IN-1252 [14074F] REV 10/2017

Contents

Introduction	3
Product Specification	3
Safety Instructions	4
Explanation of Graphic Symbols	5
Power Supply and Low Battery	6
Installing Instructions`	7
Operation: Basic Functions	9
Operation: Advanced Functions	11
Using the Scale with a Printer	15
EMC Guidance and Manufacturer's Declaration	16
Recommended Separation Distance	18
Error Messages	19
Manufacturer's Declaration of Conformity	20



EU Declaration of Conformity



The Non-Automatic Weighing Instrument

Manufacturer	Charder Electronic Co., Ltd
Model	M-605
EC Type Approval Certificate No.	T7616

The Metrological Aspects of Non-Automatic Weighing Instruments

EN45501:2015 (module D)	Notified Body Number - 0126
EN45501:1992 (module B)	Notified Body Number - 0122

The non-automatic weighing instrument corresponds to the production model described in the EC Type Approval Certificate and requirements of the following EC Directives:

2014/31/EU	Non-Automatic Weighing Instruments Directive
93/42/EEC as amended by 2007/47/EC	Medical Device Directive

The applicable harmonized standards are:

EN45501:2015	The Metrological Aspects of Non-Automatic Weighing Machines
EN ISO14971:2012	Medical devices - Application of risk management to medical devices
EN ISO10993-1:2009	Biological evaluation of medical devices - Part 1: Evaluation and testing within a risk management process
EN60601-1:2006	Medical electrical equipment - Part 1: General requirements for basic safety and essential performance
EN60601-1-2:2007	Medical electrical equipment - Part 1-2: General requirements for basic safety and essential performance - Collateral standard: Electromagnetic compatibility - Requirements and tests
EN60601-1-6:2010	Medical electrical equipment - Part 1-6: General requirements for basic safety and essential performance - Collateral standard: Usability
EN62304:2006	Medical device software - Software life-cycle processes
EN980:2008	Symbols for use in the labelling of medical devices

This declaration of conformity is issued under the sole responsibility of the manufacturer.

Date: August 28, 2017 Signature: 
 Name: Angela Lu
 Position: Measuring Management Rep.
 Place: Taichung, Taiwan

Manufacturer: Charder Electronic Co., Ltd.
 Address: NO.103, Guozhong Rd., Daili Dist., Taichung City 412, Taiwan (R.O.C.) T-152D

Thank you for purchasing a Marsden professional medical scale. This is a precision Class III Weighing Instrument and considerate use will result in many years of accurate weighing.

The scale has a maximum load capacity of 200kg which must not be exceeded.

Product Specification

Model	M-600 / M-605
Accuracy Class	Class III
Capacity/Division	200kg x 100g
Weight of Scale	Approximately 6kg / 7kg
Units of Measure	Kg
Function Keys	ON/OFF, ZERO, TARE, BMI, UNIT, HOLD, PRINT, 0-9
Stabilization Time	1-2 Seconds
Operating Temperature	0 to 40°C
Power Supply	7.2V 200mA rechargeable battery pack AC adaptor (UE24WV-120100SPA & UE24WB-120100SPA) 6 x AA batteries*
Indicator Display	2.5 cm LCD display with 5 active digits
Dimensions	M-600: 640mm x 180mm x 160mm
	M-605: 740mm x 180mm x 160mm Indicator: 210mm x 110mm x 50mm

*contact Marsden for details

Safety Instructions

Before putting the device into use, please read with care the information given in this user manual, which contains important instructions for proper installation, use and maintenance of the device.

Marsden/the manufacturer shall not be liable for damages arising from failure to heed the following instructions:

- When using electrical components under increased safety requirements, always comply with appropriate regulations.
- Inappropriate installation/use will render the warranty null and void.
- Ensure the voltage marked on the power supply unit matches your mains supply.
- This device is designed for use indoors.
- Observe the permissible ambient temperatures for use.
- The device meets the requirements for electromagnetic capability. Do not exceed the maximum values specified in the applicable standards.
- Batteries should be kept away from small children. If swallowed, promptly seek medical assistance.

If you have any problems, contact Marsden/your local dealer/your service partner.

Cleaning

- We recommend using alcohol-based wipes or similar when cleaning the scale.
- Please do not use corrosive liquids, large amounts of water or high pressure washers.
- Always disconnect the scale from the mains power supply before cleaning.

Maintenance

- The scale does not require any routine maintenance. However, we recommend checking the scale's accuracy at regular intervals. If any inaccuracies occur, please contact your local dealer or service partner.
- Repairs and service should be carried out by authorised service agents. For information regarding service contracts available from Marsden call 01709 364296.

Disposing of the Scale

- This product should not be treated as regular household waste, but should be handed in to an electrical/electronic equipment recycling centre.
- You can obtain further details from your local council, your municipal waste disposal company or from where you purchased the product.

Charder®

EU Declaration of Conformity

The Non-Automatic Weighing Instrument

III

Manufacturer	Charder Electronic Co., Ltd
Model	M-600
EC Type Approval Certificate No.	T7616

The Metrological Aspects of Non-Automatic Weighing Instruments

EN45501:2015 (module D)	Notified Body Number – 0126
EN45501:1992 (module B)	Notified Body Number – 0122

The non-automatic weighing instrument corresponds to the production model described in the EC Type Approval Certificate and requirements of the following EC Directives:

2014/31/EU	Non-Automatic Weighing Instruments Directive
93/42/EEC as amended by 2007/47/EC	Medical Device Directive

The applicable harmonized standards are:

EN45501:2015	The Metrological Aspects of Non-Automatic Weighing Machines
EN ISO14971:2012	Medical devices - Application of risk management to medical devices
EN ISO10993-1:2009	Biological evaluation of medical devices - Part 1: Evaluation and testing within a risk management process
EN60601-1:2006	Medical electrical equipment - Part 1: General requirements for basic safety and essential performance
EN60601-1-2:2007	Medical electrical equipment - Part 1-2: General requirements for basic safety and essential performance – Collateral standard: Electromagnetic compatibility - Requirements and tests
EN60601-1-6:2010	Medical electrical equipment - Part 1-6: General requirements for basic safety and essential performance - Collateral standard: Usability
EN62304:2006	Medical device software - Software life-cycle processes
EN980:2008	Symbols for use in the labelling of medical devices

This declaration of conformity is issued under the sole responsibility of the manufacturer.

Date: August 25, 2017

Signature:

Name: Angela Lu

Position: Measuring Management Rep.

Place: Taichung, Taiwan

Manufacturer: Charder Electronic Co., Ltd.

Address: NO.103, Guozhong Rd., Dali Dist., Taichung City 412, Taiwan (R.O.C.)

T-152D

Explanation of Graphic Symbols

Designation of the serial number of every device.
(Number as an example)

SN-21300100



"Please note the accompanying documents" or "Observe operating instructions"



Identification of manufacturer of medical product including address.

Charder Electronic Co. Ltd
No.103 Guozhong Rd, Dali Dist,
Taichung City 412, Taiwan (R.O.C)

Type B applied part.



Dispose of old appliances separately from your household waste. This product must be disposed of at a communal collection point.



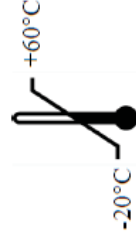

Carefully read this operation manual before setup and commissioning, even if you are already familiar with Marsden scales.



Transport and storage temperature limit indicating the upper and lower limit (transport and storage temperature on packaging).

Manufacturer's Declaration of Conformity

This product has been manufactured in accordance with the harmonized European standards, following the provisions of the below stated directives.

	93/42/EEC as amended by 2007/47/EC Medical Device Directive
	2014/31/EU Non-automatic Weighing Instruments Directive

Please see separate document showing on sticker of device for above CE marking.

Authorized EU Representative:

 **Wellkang Ltd**
Suite B, 29 Harley Street
LONDON, W1G 9QR, U.K.

Manufactured by:

 Charder Electronic Co., Ltd.
No.103, Guozhong Rd., Dali Dist.,
Taichung City 412, Taiwan (R.O.C.)

Power Supply & Low Battery

The indicator uses a rechargeable battery pack, or can be powered from the mains via the AC adaptor.

Make sure the battery pack is installed in the battery box of the indicator. Alternatively, plug the AC adaptor (12V 1A) into the port on the side of the indicator.



Installing & Replacing the Battery Pack

1. Take out the battery housing.
2. The rechargeable battery pack will slide into, or out of, the housing.
3. Check that the housing pin is connecting to the right point inside the indicator.

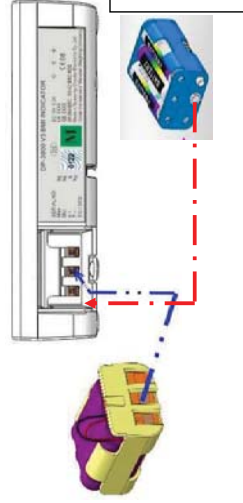

4. Place the housing back in the back of the indicator, and close the battery housing cover.

Error Messages

<p>Low Battery The scale's alkaline AA type batteries are flat; please replace the batteries.</p>	
<p>Overload This indicates that the scale's load sensor(s) have been overloaded. Reduce the loading and retry.</p>	
<p>Counting Error</p> <ol style="list-style-type: none"> 1. The signal from the load cells is too high. Please remove any weight from the scale and try to power on again. If the scale continues to show the error message, it indicates a fault with the electronics or wiring. 2. The signal from the load cells is too low. Please remove any weight from the scale and try again. If the scale continues to show the error message, it indicates a fault with the electronics or wiring. 	
<p>High/Low Zero Count</p> <ol style="list-style-type: none"> 1. The scale is above its zero range. Please remove any weight from the scale and power on again. If the scale continues to show the error message, it indicates a fault with the electronics. 2. The scale is below its zero range. Check there is nothing jammed underneath the scale and power on again. If the scale continues to show the error message, it indicates a fault with the electronics. 	
<p>EEPROM Error This indicates there is a fault with the scale's software and is normally caused by a fault with the load cell or wiring. Contact your local service representative.</p>	

Installation Instructions

1. To attach the indicator to the hoist weighing attachment, first unscrew the two thumb screws from the rear of the indicator display.

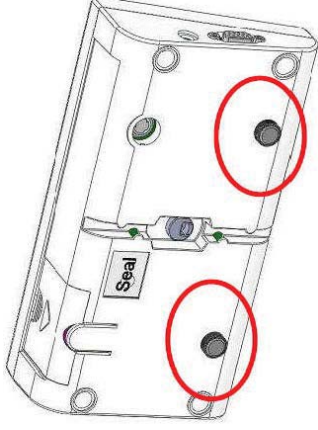

2. Mount the indicator to the front of the hoist attachment. Secure in the position shown using the two thumb screws.

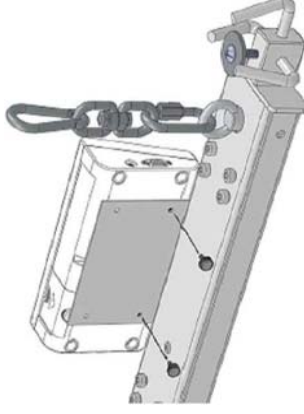

3. Your M-600/M-605 is now ready to use.



Radiated RF IEC 61000-4-3	3 V/m 80 MHz to 2.5 GHz	3 V/m	frequency range. Interference may occur in the vicinity of equipment marked with the following symbol:
<p>NOTE1 At 80 MHz and 800 MHz, the higher frequency range applies. NOTE2 These guidelines may not apply in all situations. Electromagnetic propagation is affected by absorption and reflection from structures, objects and people.</p> <p>A) Field strengths from fixed transmitters, such as base stations for radio (cellular/cordless) telephones and land mobile radios, amateur radio, AM and FM radio broadcast and TV broadcast cannot be predicted theoretically with accuracy. To assess the electromagnetic environment due to fixed RF transmitters, an electromagnetic site survey should be considered. If the measured field strength in the location in which the scale is used exceeds the application RF compliance level above, the scale should be observed to verify normal operation. If abnormal performance is observed, additional measures may be necessary, such as re-orienting or relocating the scale.</p> <p>B) Over the frequency range 150 kHz to 80 MHz, field strengths should be less than 3 V/m.</p>			

Recommended separation distance between portable and mobile RF communications equipment and the M-600/M-605.

This scale is intended for use in an electromagnetic environment in which radiated RF disturbances are controlled. The customer or the user of the scale can help prevent electromagnetic interference by maintaining a minimum distance between portable and mobile RF communications equipment (transmitters) and the scale as recommended below, according to the maximum output power of the communications equipment.

Rated maximum output power of transmitter	Separation distance according to frequency of transmitter m	
	150 kHz to 80 MHz	80 MHz to 800 MHz
W	$d = 1,2\sqrt{P}$	$d = 1,2\sqrt{P}$
0.01	0.12	0.12
0.1	0.38	0.38
1	1.2	1.2
10	3.8	3.8
100	12	12
		$d = 2,3\sqrt{P}$
		0.23
		0.73
		2.3
		7.3
		23

For transmitters rated at a maximum output power not listed above, the recommended separation distance d in meters (m) can be estimated using the equation applicable to the frequency of the transmitter, where p is the maximum output rating of the transmitter in watts (w) according to the transmitter manufacturer.

NOTE1) At 80 MHz and 800 MHz, the separation distance for the high frequency range applies.

NOTE2) These guidelines may not apply in all situations. Electromagnetic propagation is affected by absorption and reflection from structures, objects and people.

- Attach master links of the M-600/M-605 to the spreader bar of the patient lift.

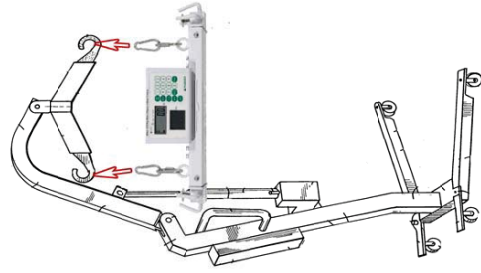

- Place the patient in the sling and attach the sling loops onto the hooks on both sides of the hoist weighing attachment. The design and procedure may vary depending on the different sling makers. Please refer to the instructions provided by the sling manufacturer.

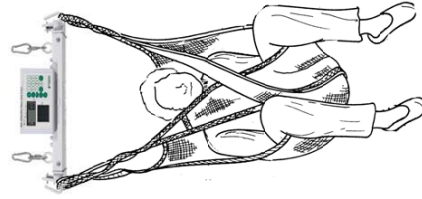

Voltage Dips, short interruptions and voltage variations on power supply input lines IEC 61000-4-11	<5% UT (>95% dip in UT) for 0.5 cycle 40% UT (60% dip in UT) for 5 cycles 70% UT (30% dip in UT) for 25 cycles <5% UT (>95% dip in UT) for 5s	<5% UT (95% dip in UT) for 0.5 cycle 40% UT (60% dip in UT) for 5 cycles 70% UT (30% dip in UT) for 25 cycles <5% UT (>95% dip in UT) for 5s	Mains power quality should be that of a typical commercial or hospital environment. If the user of this scale requires continued operation during power mains interruptions, it is recommended that this scale is powered from an uninterruptable power supply or a battery.
Power frequency (50/60 Hz) magnetic field IEC 61000-4-8	3 A/m	3 A/m	The scale's power frequency magnetic fields should be at levels characteristic of a typical location in a typical commercial or hospital environment.
Note UT is the A.C mains voltage prior to application of the test level.			

Guidance and manufacturer's declaration – electromagnetic immunity.

This scale is intended for use in the electromagnetic environment specified below. The customer or the user of the scale should ensure that it is used in such an environment.

Immunity Test	IEC 60601 test level	Compliance level	Electromagnetic environment-guidance
Conducted RF IEC 61000-4-6	3 Vrms 150 KHz to 80 MHz	3 Vrms	Portable and mobile RF communications equipment should be used no closer to any part of the scale including cables, than the recommended separation distance calculated from the equation applicable to the frequency of the transmitter. Recommended separation distance: $d = 1,2 \sqrt{P}$ $d = 1,2 \sqrt{P} 80\text{MHz to } 800\text{ MHz}$ $d = 2,3 \sqrt{P} 800\text{MHz to } 2,5\text{ GHz}$ Where P is the maximum output power rating of the transmitter in watts (w) according to the transmitter manufacturer and d is the recommended separation distance in meters (m). Field strengths from fixed RF transmitters, as determined by an electromagnetic site survey, should be less than the compliance level in each

Operation: Basic Functions

EMC Guidance and Manufacturer's Declaration

Switching on the Scale

Guidance and manufacturer's declaration – electromagnetic emissions.

The M-600/M-605 is intended for use in the electromagnetic environment specified below. The customer or user of this scale should ensure that it is used in such environment.

Emission Test	Compliance	Electromagnetic environment-guidance
RF emissions CISPR 11	Group 1	This scale uses RF energy only for its internal function. Therefore, its RF emissions are very low and not likely to cause any interference in nearby electronic equipment.
RF emissions CISPR 11	Class B	This scale is suitable for use in all establishments, including domestic establishments and those directly connected to the public low-voltage power supply network that supplies buildings used for domestic purposes.
Harmonic emissions IEC 61000-3-2	Class A	
Voltage fluctuations/flicker emissions IEC 61000-3-3	Compliance	

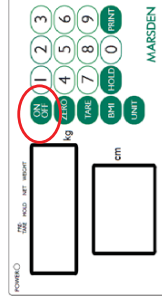

Press ON/OFF firmly.

The scale will first test all of the display segments.

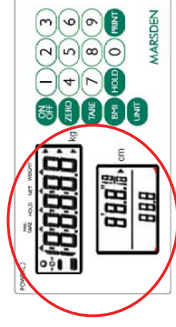

The scale will now show its current software version number.

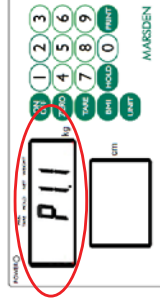

The scale will now go into weighing mode and should show 0.0 on the display.

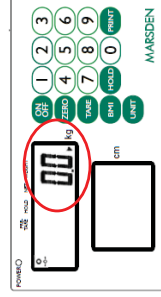

Guidance and manufacturer's declaration – electromagnetic immunity.

The M-600/M-605 is intended for use in the electromagnetic environment specified below. The customer or the user of this scale should ensure that it is used in such an environment.

Immunity Test	IEC 60601 Test Level	Compliance Level	Electromagnetic Environment Guidance
Electrostatic discharge (ESD) IEC 61000-4-2	± 6 kV contact ± 8 kV air	± 6 kV contact ± 8 kV air	Floors should be wood, cement or ceramic tile. If floors are covered with synthetic material, the relative humidity should be at least 30%.
Electrical fast transient/burst IEC 61000-4-4	± 2 kV for power supply lines +1 kV for input/output lines	± 2 kV for power supply lines not applicable	Mains power quality should be that of a typical commercial or hospital environment.
Surge IEC 61000-4-5	± 1 kV line(s) to line(s) ± 2 kV line(s) to earth	± 1 kV differential mode not applicable	Mains power quality should be that of a typical commercial or hospital environment.

Switching off the Scale

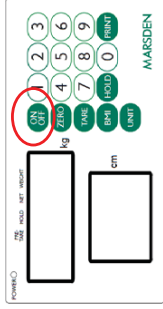

Press ON/OFF when the scale is turned on.
The scale will now power down.

Setting the Scale to Zero

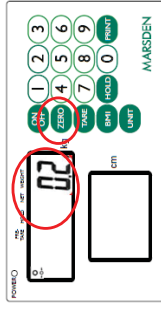

If for any reason the scale shows a reading other than 0.0 it can be reset to zero.

Press ZERO once.

The scale will return to 0.0.

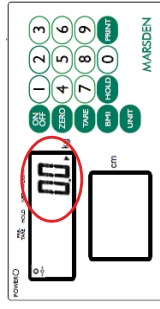

Using the Scale with a Printer

An optional Marsden external printer (model TP-2100) is available for all models. When the printer is fitted, the patient's weight, height, and BMI result can be printed.

Once the person has been weighed and their BMI calculated, simply press PRINT to produce the following ticket:

GROSS WEIGHT	60.00kg
TARE WEIGHT	30.00kg
NET WEIGHT	30.00kg
PATIENT HEIGHT	100.00cm
PATIENT B.M.I	37.5
	29/12/2008 17:00

Connecting the TP-2100 Thermal Printer



Plug the cable to the printer, and then connect its 9D connector to the indicator.

Setting the Date

Press HOLD for three seconds to access the time setting mode. The time period digit that is flashing can be changed by entering the appropriate number with the numeric keys. The time period to be edited is selected by pressing HOLD.

E.g. To input 25 December 2008, 8:00 a.m.:



Enter the year. Press HOLD to confirm and access the date editing field.



Enter the date. E.g. "12.25" for December 25th. Press HOLD to confirm and access the time clock editing field.



Enter the time (24 hour clock only).



Press HOLD and the display shows:
YYYY → MM.DD → HH:SS



Press HOLD to return to normal weighing mode.

Hold Function

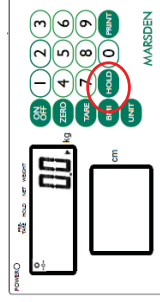

Press HOLD once.

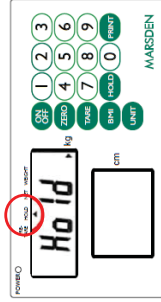

Allow the patient to get on the scale.

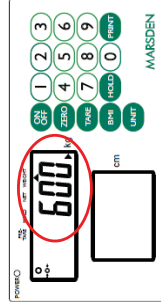

After a few seconds the scale will lock on the person's weight. When the patient leaves the scale, the weight will remain on the display.

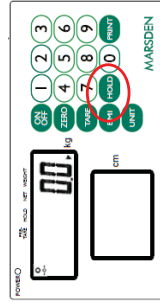

Press HOLD again to disable the Hold function and return the scale to 0.0.

Body Mass Index (BMI) Function

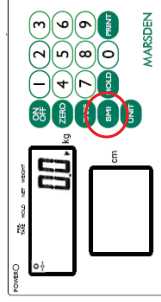

In normal mode, press BMI to enter BMI mode.

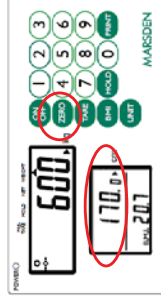

The display will show the last height entered and the extreme left digit will flash. Enter the height by using the numeric keys. Press ZERO to confirm the height. (NB: There will always be an active flashing digit in the height display, unless HOLD is pressed).

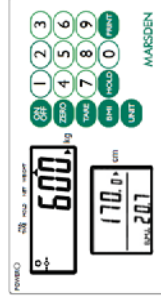

Weigh the patient as normal. The display will show the weight, height and BMI value. At this time, the weight and height can be freely changed, and the BMI value will be automatically calculated according to the changed weight and height.

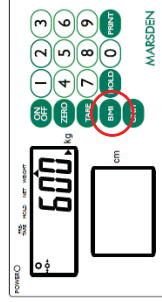

Press BMI to return to normal weighing mode.

Tare and Preset Tare Functions

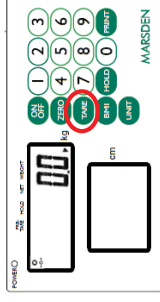

To enter Preset Tare setting mode, Press TARE for three seconds. When the cursor points to Pre Tare on the display press TARE once more. The display will show the last preset tare entered.

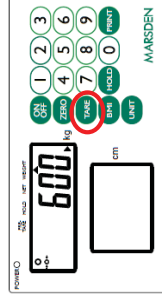

The left digit on the display will flash. Enter the preset tare value by using the numeric keys, then press TARE again to confirm the value.

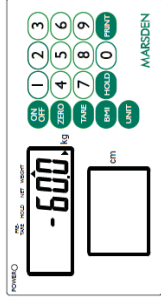

The display will now show the figure you entered deducted from 0.0. The scale is now ready to use.

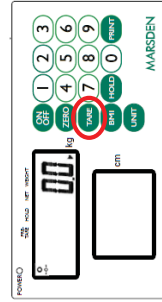

To use the Tare function, add the item you wish to tare off to the scale, and press TARE. The display will show zero, and then a minus number when the item is removed from the scale.